

规格书 | 型号: 2102-5301

3线普通接线端子; 具有操作手柄及推压键; 2.5 mm²; 有测试插孔; 侧面/中心标记; 适于35 x 15 和 35 x 7.5导轨; Push-in CAGE CLAMP®; 2,50 mm²; 灰色

www.wago.com/2102-5301

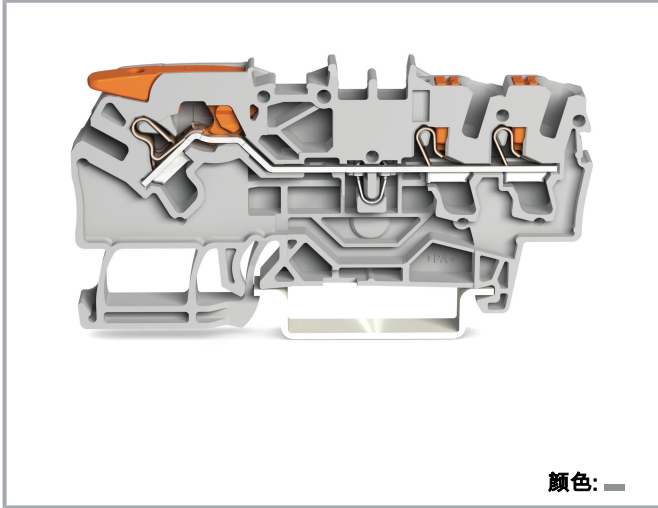

颜色: ■

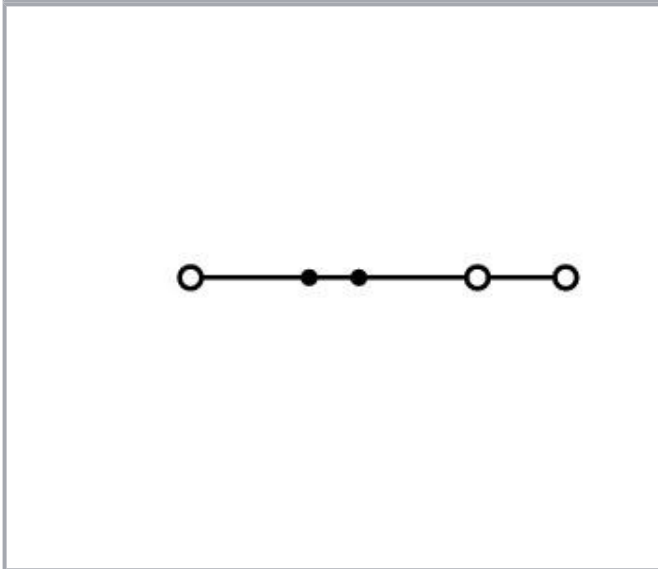
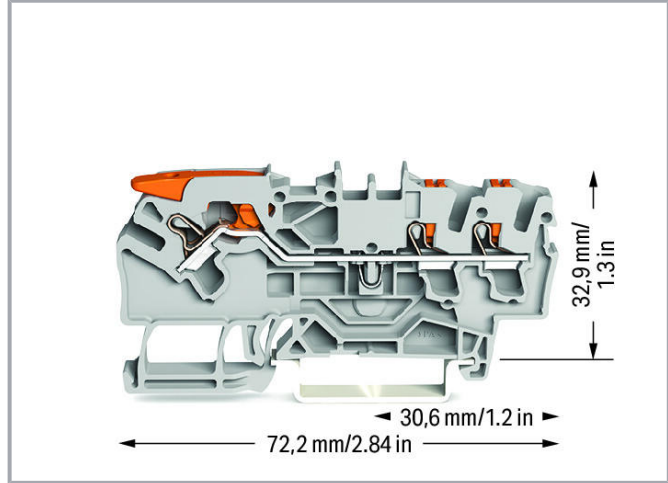

数据

电气参数

Ratings per IEC/EN

额定电气参数依据的标准

IEC/EN 60947-7-1

变更声明。敬请关注进一步的产品说明文件！

WAGO Electronic (Tianjin) Co., Ltd.
No.5, Quan Hui Road
Wuqing Development Area | Tianjin 301700
Tel.: +86 22 59677688 | Fax: +86 22 59617668
Email: info-cn@wago.com

您有关于我们产品的任何问题吗？
我们非常乐意接听您的来电，+86 (022) 59677688。

额定电压(III/3)	800 V
额定浪涌电压(III/3)	8 kV
额定电流	24 A
额定电流2	30 A
图例(额定电气参数)	(III / 3) Δ 过电压类别III/污染等级3

Approvals per UL

认证	UL 1059
额定电压 UL(Use Group B)	600 V
额定电流 UL(Use Group B)	20 A
额定电压 UL(Use Group C)	600 V
额定电流 UL(Use Group C)	20 A

Approvals per CSA

认证	C22.2 No 158
额定电压 CSA (Use Group B)	600 V
额定电流 CSA (Use Group B)	20 A
额定电压 CSA (Use Group C)	600 V
额定电流 CSA (Use Group C)	20 A

Ex information

Ratings per	ATEX: PTB 18 ATEX 1010 U / IECEx: PTB 18.0001U (Ex eb IIC Gb)
额定电压EN (Ex e II)	550 V
额定电流(Ex e II)	20.5 A
带跨接器时的额定电流((Ex e II)	20 A

接线参数

连接技术	直插型笼式弹簧接线单元(Push-in CAGE CLAMP®)
执行类型	推入式 操作手柄 推入 操作元件
执行类型2	推入式 推压键 操作工具 推入 操作元件 螺丝刀

变更声明。敬请关注进一步的产品说明文件！

WAGO Electronic (Tianjin) Co., Ltd.
 No.5, Quan Hui Road
 Wuqing Development Area | Tianjin 301700
 Tel.: +86 22 59677688 | Fax: +86 22 59617668
 Email: info-cn@wago.com

您有关于我们产品的任何问题吗？
 我们非常乐意接听您的来电，+86 (022) 59677688。

可连接导线材料	铜
额定导线截面积	2.5 mm ²
单股导线	0.25 ... 4 mm ² / 22 ... 12 AWG
单股导线；可直接插入	0.75 ... 4 mm ² / 18 ... 12 AWG
细多股导线	0.25 ... 4 mm ² / 22 ... 12 AWG
细多股导线；加有带绝缘护套的冷压接头	0.25 ... 2.5 mm ² / 22 ... 14 AWG
细多股导线；加有冷压接头；可直接插入	1 ... 2.5 mm ² / 18 ... 14 AWG
说明(导线截面积)	横截面较小的导线也可以直接插入,具体取决于导线特性。
剥线长度	10 ... 12 mm / 0.39 ... 0.47 英寸
连接点总数	3
电位总数量	1
层数	1
接线类型	正面接线
跨接器插孔数量	2

Geometrical Data

宽度	5.2 mm / 0.205 inch
高度	72.2 mm / 2.843 inch
以DIN导轨的上边线为基准的深度	32.9 mm / 1.295 inch

机械参数

设计	水平型
安装方式	DIN-35型导轨 DIN-35 导轨
标记位	中央/侧面标记位

材料参数

颜色	灰色
绝缘材料	尼龙66 (PA 66)
重量	8.1 g

商业数据

包装类型	BOX
原产国	DE
GTIN	4055143741927
海关税号	85369010000

变更声明。敬请关注进一步的产品说明文件！

WAGO Electronic (Tianjin) Co., Ltd.
No.5, Quan Hui Road
Wuqing Development Area | Tianjin 301700
Tel.: +86 22 59677688 | Fax: +86 22 59617668
Email: info-cn@wago.com

您有关于我们产品的任何问题吗？
我们非常乐意接听您的来电，+86 (022) 59677688。

认证 / 证书

Ex防爆认证

标识	认证	其他认证信息	认证名称
	AEx Underwriters Laboratories Inc.	UL 60079	20181105-E185892
	ATEX Physikalisch Technische Bundesanstalt	EN 60079-0	PTB 18 ATEX 1010 U
	CCCEX CQST/CNEx	CNCA-C23-01	2020312313000163
	EAC Brjansker Zertifizierungsstelle	TP TC 012/2011	RU C-DE.AM02.B. 00127/19
	IECEX Physikalisch Technische Bundesanstalt	IEC 60079-0	IECEX PTB 18.0017U

船级社认证

标识	认证	其他认证信息	认证名称
	CCA DEKRA Certification B.V.	EN 60947	NTR NL 7670
	CSA DEKRA Certification B.V.	C22.2	70175030
	KEMA/KEUR DEKRA Certification B.V.	EN 60947	71- 102882

船级社认证

标识	认证	其他认证信息	认证名称
	ABS American Bureau of Shipping	-	9- HG1866350-

变更声明。敬请关注进一步的产品说明文件！

WAGO Electronic (Tianjin) Co., Ltd.
No.5, Quan Hui Road
Wuqing Development Area | Tianjin 301700
Tel.: +86 22 59677688 | Fax: +86 22 59617668
Email: info-cn@wago.com

您有关于我们产品的任何问题吗？
我们非常乐意接听您的来电，+86 (022) 59677688。



DNV GL

Det Norske Veritas, Germanischer Lloyd

-

TAE00003JT

LR

Lloyds Register

-



19/20050

UL-Approvals

标识	认证	其他认证信息	认证名称
	cURus Underwriters Laboratories Inc.	UL 1059	20190731- E45172





所需附件

End plate

	型号: 2102-1391 端板和隔板; 厚度 0.8 mm; 适用于3线接线端子; 灰色	www.wago.com/2102-1391
	型号: 2102-1392 端板和隔板; 厚度 0.8 mm; 适用于3线接线端子; 橙色	www.wago.com/2102-1392

适用产品

Marking accessories

	型号: 2002-161 适配器; 灰色	www.wago.com/2002-161
	型号: 2009-110 标记条; 适于Smart Printer; 卷装; not stretchable; 空白; 卡装式; 白色	www.wago.com/2009-110
	型号: 2009-115 WMB-Inline; 适于Smart Printer; 每卷1500个标记; 5 - 5.2 mm可伸缩; 空白; 卡装式; 白色	www.wago.com/2009-115
	型号: 2009-115/000-002 WMB-Inline; 适于Smart Printer; 每卷1500个标记; 5 - 5.2 mm可伸缩; 空白; 卡装式; 黄色	www.wago.com/2009-115/000-002

变更声明。敬请关注进一步的产品说明文件！

WAGO Electronic (Tianjin) Co., Ltd.
No.5, Quan Hui Road
Wuqing Development Area | Tianjin 301700
Tel.: +86 22 59677688 | Fax: +86 22 59617668
Email: info-cn@wago.com

您有关于我们产品的任何问题吗？
我们非常乐意接听您的来电， +86 (022) 59677688。



<p>• 型号: 2009-115/000-006 WMB-Inline; 适于Smart Printer; 每卷1500个标记; 5 - 5.2 mm可伸缩; 空白; 卡装式; 蓝色</p>	<p>www.wago.com/2009-115/000-006</p>
<p>• 型号: 2009-115/000-007 WMB-Inline; 适于Smart Printer; 每卷1500个标记; 5 - 5.2 mm可伸缩; 空白; 卡装式; 灰色</p>	<p>www.wago.com/2009-115/000-007</p>
<p>• 型号: 2009-115/000-012 WMB-Inline; 适于Smart Printer; 每卷1500个标记; 5 - 5.2 mm可伸缩; 空白; 卡装式; 橙色</p>	<p>www.wago.com/2009-115/000-012</p>
<p>• 型号: 2009-115/000-017 WMB-Inline; 适于Smart Printer; 每卷1500个标记; 5 - 5.2 mm可伸缩; 空白; 卡装式; 浅绿色</p>	<p>www.wago.com/2009-115/000-017</p>
<p>• 型号: 2009-115/000-023 WMB-Inline; 适于Smart Printer; 每卷1500个标记; 5 - 5.2 mm可伸缩; 空白; 卡装式; 绿色</p>	<p>www.wago.com/2009-115/000-023</p>
<p>• 型号: 2009-115/000-024 WMB-Inline; 适于Smart Printer; 每卷1500个标记; 5 - 5.2 mm可伸缩; 空白; 卡装式; 紫色</p>	<p>www.wago.com/2009-115/000-024</p>
<p>✓ 型号: 2009-145 Mini-WSB Inline; 适于Smart Printer; 每卷1700个标记; 5 - 5.2 mm可伸缩; 空白; 卡装式; 白色</p>	<p>www.wago.com/2009-145</p>
<p>✓ 型号: 2009-145/000-002 Mini-WSB Inline; 适于Smart Printer; 每卷1700个标记; 5 - 5.2 mm可伸缩; 空白; 卡装式; 黄色</p>	<p>www.wago.com/2009-145/000-002</p>
<p>✓ 型号: 2009-145/000-005 Mini-WSB Inline; 适于Smart Printer; 每卷1700个标记; 5 - 5.2 mm可伸缩; 空白; 卡装式; 红色</p>	<p>www.wago.com/2009-145/000-005</p>
<p>✓ 型号: 2009-145/000-006 Mini-WSB Inline; 适于Smart Printer; 每卷1700个标记; 5 - 5.2 mm可伸缩; 空白; 卡装式; 蓝色</p>	<p>www.wago.com/2009-145/000-006</p>
<p>✓ 型号: 2009-145/000-007 Mini-WSB Inline; 适于Smart Printer; 每卷1700个标记; 5 - 5.2 mm可伸缩; 空白; 卡装式; 灰色</p>	<p>www.wago.com/2009-145/000-007</p>
<p>✓ 型号: 2009-145/000-012 Mini-WSB Inline; 适于Smart Printer; 每卷1700个标记; 5 - 5.2 mm可伸缩; 空白; 卡装式; 橙色</p>	<p>www.wago.com/2009-145/000-012</p>
<p>✓ 型号: 2009-145/000-023 Mini-WSB Inline; 适于Smart Printer; 每卷1700个标记; 5 - 5.2 mm可伸缩; 空白; 卡装式; 绿色</p>	<p>www.wago.com/2009-145/000-023</p>
<p>✓ 型号: 2009-145/000-024 Mini-WSB Inline; 适于Smart Printer; 每卷1700个标记; 5 - 5.2 mm可伸缩; 空白; 卡装式; 紫色</p>	<p>www.wago.com/2009-145/000-024</p>

变更声明。敬请关注进一步的产品说明文件！

WAGO Electronic (Tianjin) Co., Ltd.
No.5, Quan Hui Road
Wuqing Development Area | Tianjin 301700
Tel.: +86 22 59677688 | Fax: +86 22 59617668
Email: info-cn@wago.com

您关于我们产品的任何问题吗？
我们非常乐意接听您的来电， +86 (022) 59677688。

	型号: 2009-191 组标记支架	www.wago.com/2009-191
	型号: 2009-192 组标记支架	www.wago.com/2009-192
	型号: 2009-193 组标记支架	www.wago.com/2009-193
	型号: 2009-198 适配器; 灰色	www.wago.com/2009-198
	型号: 248-501 Mini-WSB标记牌; 详见卡片; not stretchable; 空白; 卡装式; 白色	www.wago.com/248-501
	型号: 248-501/000-002 Mini-WSB标记牌; 详见卡片; not stretchable; 空白; 卡装式; 黄色	www.wago.com/248-501/000-002
	型号: 248-501/000-005 Mini-WSB标记牌; 详见卡片; not stretchable; 空白; 卡装式; 红色	www.wago.com/248-501/000-005
	型号: 248-501/000-006 Mini-WSB标记牌; 详见卡片; not stretchable; 空白; 卡装式; 蓝色	www.wago.com/248-501/000-006
	型号: 248-501/000-007 Mini-WSB标记牌; 详见卡片; not stretchable; 空白; 卡装式; 灰色	www.wago.com/248-501/000-007
	型号: 248-501/000-012 Mini-WSB标记牌; 详见卡片; not stretchable; 空白; 卡装式; 橙色	www.wago.com/248-501/000-012
	型号: 248-501/000-017 Mini-WSB标记牌; 详见卡片; not stretchable; 空白; 卡装式; 浅绿色	www.wago.com/248-501/000-017
	型号: 248-501/000-023 Mini-WSB标记牌; 详见卡片; not stretchable; 空白; 卡装式; 绿色	www.wago.com/248-501/000-023
	型号: 248-501/000-024 Mini-WSB标记牌; 详见卡片; not stretchable; 空白; 卡装式; 紫色	www.wago.com/248-501/000-024
	型号: 793-501 WMB标记卡; 详见卡片; not stretchable; 空白; 卡装式; 白色	www.wago.com/793-501
	型号: 793-501/000-002 WMB标记卡; 详见卡片; not stretchable; 空白; 卡装式; 黄色	www.wago.com/793-501/000-002

变更声明。敬请关注进一步的产品说明文件！

WAGO Electronic (Tianjin) Co., Ltd.
No.5, Quan Hui Road
Wuqing Development Area | Tianjin 301700
Tel.: +86 22 59677688 | Fax: +86 22 59617668
Email: info-cn@wago.com

您有关于我们产品的任何问题吗？
我们非常乐意接听您的来电，+86 (022) 59677688。

	型号: 793-501/000-005 WMB标记卡; 详见卡片; not stretchable; 空白; 卡装式; 红色	www.wago.com/793-501/000-005
	型号: 793-501/000-006 WMB标记卡; 详见卡片; not stretchable; 空白; 卡装式; 蓝色	www.wago.com/793-501/000-006
	型号: 793-501/000-007 WMB标记卡; 详见卡片; not stretchable; 空白; 卡装式; 灰色	www.wago.com/793-501/000-007
	型号: 793-501/000-012 WMB标记卡; 详见卡片; not stretchable; 空白; 卡装式; 橙色	www.wago.com/793-501/000-012
	型号: 793-501/000-017 WMB标记卡; 详见卡片; not stretchable; 空白; 卡装式; 浅绿色	www.wago.com/793-501/000-017
	型号: 793-501/000-023 WMB标记卡; 详见卡片; not stretchable; 空白; 卡装式; 绿色	www.wago.com/793-501/000-023
	型号: 793-501/000-024 WMB标记卡; 详见卡片; not stretchable; 空白; 卡装式; 紫色	www.wago.com/793-501/000-024
	型号: 793-5501 WMB标记卡; 详见卡片; 用于接线端子厚度 5 - 17.5 mm; 5 - 5.2 mm可伸缩; 空白; 卡装式; 白色	www.wago.com/793-5501
	型号: 793-5501/000-002 WMB标记卡; 详见卡片; 用于接线端子厚度 5 - 17.5 mm; 5 - 5.2 mm可伸缩; 空白; 卡装式; 黄色	www.wago.com/793-5501/000-002
	型号: 793-5501/000-005 WMB标记卡; 详见卡片; 用于接线端子厚度 5 - 17.5 mm; 5 - 5.2 mm可伸缩; 空白; 卡装式; 红色	www.wago.com/793-5501/000-005
	型号: 793-5501/000-006 WMB标记卡; 详见卡片; 用于接线端子厚度 5 - 17.5 mm; 5 - 5.2 mm可伸缩; 空白; 卡装式; 蓝色	www.wago.com/793-5501/000-006
	型号: 793-5501/000-007 WMB标记卡; 详见卡片; 用于接线端子厚度 5 - 17.5 mm; 5 - 5.2 mm可伸缩; 空白; 卡装式; 灰色	www.wago.com/793-5501/000-007
	型号: 793-5501/000-012 WMB标记卡; 详见卡片; 用于接线端子厚度 5 - 17.5 mm; 5 - 5.2 mm可伸缩; 空白; 卡装式; 橙色	www.wago.com/793-5501/000-012
	型号: 793-5501/000-017 WMB标记卡; 详见卡片; 用于接线端子厚度 5 - 17.5 mm; 5 - 5.2 mm可伸缩; 空白; 卡装式; 绿色	www.wago.com/793-5501/000-017

变更声明。 敬请关注进一步的产品说明文件！

WAGO Electronic (Tianjin) Co., Ltd.
No.5, Quan Hui Road
Wuqing Development Area | Tianjin 301700
Tel.: +86 22 59677688 | Fax: +86 22 59617668
Email: info-cn@wago.com

您有关于我们产品的任何问题吗？
我们非常乐意接听您的来电， +86 (022) 59677688。

	型号: 793-5501/000-023 WMB标记卡; 详见卡片; 用于接线端子厚度 5 - 17.5 mm; 5 - 5.2 mm可伸缩; 空白; 卡装式; 浅绿色	www.wago.com/793-5501/000-023
---	--	--

	型号: 793-5501/000-024 WMB标记卡; 详见卡片; 用于接线端子厚度 5 - 17.5 mm; 5 - 5.2 mm可伸缩; 空白; 卡装式; 紫色	www.wago.com/793-5501/000-024
---	---	--

Jumper

	型号: 2002-400 连续跨接器; 2插脚; 绝缘; 浅灰色	www.wago.com/2002-400
---	--	--

	型号: 2002-402 跨接器; 2插脚; 绝缘; 浅灰色	www.wago.com/2002-402
---	--	--

	型号: 2002-402/000-005 跨接器; 2插脚; 绝缘; 红色	www.wago.com/2002-402/000-005
---	---	--

	型号: 2002-402/000-006 跨接器; 2插脚; 绝缘; 蓝色	www.wago.com/2002-402/000-006
---	---	--

	型号: 2002-403 跨接器; 3插脚; 绝缘; 浅灰色	www.wago.com/2002-403
---	--	--

	型号: 2002-403/000-005 跨接器; 3插脚; 绝缘; 红色	www.wago.com/2002-403/000-005
---	---	--

	型号: 2002-403/000-006 跨接器; 3插脚; 绝缘; 蓝色	www.wago.com/2002-403/000-006
---	---	--

	型号: 2002-404 跨接器; 4插脚; 绝缘; 浅灰色	www.wago.com/2002-404
---	--	--

	型号: 2002-404/000-005 跨接器; 4插脚; 绝缘; 红色	www.wago.com/2002-404/000-005
---	---	--

	型号: 2002-404/000-006 跨接器; 4插脚; 绝缘; 蓝色	www.wago.com/2002-404/000-006
---	---	--















	型号: 2002-405 跨接器; 5插脚; 绝缘; 浅灰色	www.wago.com/2002-405
---	--	--

	型号: 2002-405/000-005 跨接器; 5插脚; 绝缘; 红色	www.wago.com/2002-405/000-005
---	---	--

变更声明。敬请关注进一步的产品说明文件！

WAGO Electronic (Tianjin) Co., Ltd.
No.5, Quan Hui Road
Wuqing Development Area | Tianjin 301700
Tel.: +86 22 59677688 | Fax: +86 22 59617668
Email: info-cn@wago.com

您有关于我们产品的任何问题吗？
我们非常乐意接听您的来电， +86 (022) 59677688。

	型号: 2002-405/000-006 跨接器; 5插脚; 绝缘; 蓝色	www.wago.com/2002-405/000-006
	型号: 2002-405/011-000 起点跨接器; 3插脚; 绝缘; 浅灰色	www.wago.com/2002-405/011-000
	型号: 2002-406 跨接器; 6插脚; 绝缘; 浅灰色	www.wago.com/2002-406
	型号: 2002-406/000-005 跨接器; 6插脚; 绝缘; 红色	www.wago.com/2002-406/000-005
	型号: 2002-406/000-006 跨接器; 6插脚; 绝缘; 蓝色	www.wago.com/2002-406/000-006
	型号: 2002-406/020-000 三角形接法跨接器; 绝缘; 浅灰色	www.wago.com/2002-406/020-000
	型号: 2002-407 跨接器; 7插脚; 绝缘; 浅灰色	www.wago.com/2002-407
	型号: 2002-407/000-005 跨接器; 7插脚; 绝缘; 红色	www.wago.com/2002-407/000-005
	型号: 2002-407/000-006 跨接器; 7插脚; 绝缘; 蓝色	www.wago.com/2002-407/000-006
	型号: 2002-408 跨接器; 8插脚; 绝缘; 浅灰色	www.wago.com/2002-408
	型号: 2002-408/000-005 跨接器; 8插脚; 绝缘; 红色	www.wago.com/2002-408/000-005
	型号: 2002-408/000-006 跨接器; 8插脚; 绝缘; 蓝色	www.wago.com/2002-408/000-006
	型号: 2002-409 跨接器; 9插脚; 绝缘; 浅灰色	www.wago.com/2002-409
	型号: 2002-409/000-005 跨接器; 9插脚; 绝缘; 红色	www.wago.com/2002-409/000-005
	型号: 2002-409/000-006 跨接器; 9插脚; 绝缘; 蓝色	www.wago.com/2002-409/000-006

变更声明。敬请关注进一步的产品说明文件！

WAGO Electronic (Tianjin) Co., Ltd.
No.5, Quan Hui Road
Wuqing Development Area | Tianjin 301700
Tel.: +86 22 59677688 | Fax: +86 22 59617668
Email: info-cn@wago.com

















您有关于我们产品的任何问题吗？
我们非常乐意接听您的来电，+86 (022) 59677688。

	型号: 2002-410 跨接器; 10插脚; 绝缘; 浅灰色	www.wago.com/2002-410
	型号: 2002-410/000-005 跨接器; 10插脚; 绝缘; 红色	www.wago.com/2002-410/000-005
	型号: 2002-410/000-006 跨接器; 10插脚; 绝缘; 蓝色	www.wago.com/2002-410/000-006
	型号: 2002-423 连续跨接器; 从1到3; 绝缘; 浅灰色	www.wago.com/2002-423
	型号: 2002-423/000-005 连续跨接器; 从1到3; 绝缘; 红色	www.wago.com/2002-423/000-005
	型号: 2002-423/000-006 连续跨接器; 从1到3; 绝缘; 蓝色	www.wago.com/2002-423/000-006
	型号: 2002-433 跨接器; 从1到3; 绝缘; 浅灰色	www.wago.com/2002-433
	型号: 2002-434 跨接器; 从1到4; 绝缘; 浅灰色	www.wago.com/2002-434
	型号: 2002-435 跨接器; 从1到5; 绝缘; 浅灰色	www.wago.com/2002-435
	型号: 2002-436 跨接器; 从1到6; 绝缘; 浅灰色	www.wago.com/2002-436
	型号: 2002-437 跨接器; 从1到7; 绝缘; 浅灰色	www.wago.com/2002-437
	型号: 2002-438 跨接器; 从1到8; 绝缘; 浅灰色	www.wago.com/2002-438
	型号: 2002-439 跨接器; 从1到9; 绝缘; 浅灰色	www.wago.com/2002-439
	型号: 2002-440 跨接器; 从1到10; 绝缘; 浅灰色	www.wago.com/2002-440
	型号: 2002-472 交错跨接器; 2插脚; 绝缘; 浅灰色	www.wago.com/2002-472
	型号: 2002-473 交错跨接器; 3插脚; 绝缘; 浅灰色	www.wago.com/2002-473

变更声明。敬请关注进一步的产品说明文件！

WAGO Electronic (Tianjin) Co., Ltd.
No.5, Quan Hui Road
Wuqing Development Area | Tianjin 301700
Tel.: +86 22 59677688 | Fax: +86 22 59617668
Email: info-cn@wago.com

您有关于我们产品的任何问题吗？
我们非常乐意接听您的来电，+86 (022) 59677688。

	型号: 2002-473/011-000 交错跨接器; 2插脚; 从1到3; 绝缘; 浅灰色	www.wago.com/2002-473/011-000
	型号: 2002-474 交错跨接器; 4插脚; 绝缘; 浅灰色	www.wago.com/2002-474
	型号: 2002-475 交错跨接器; 5插脚; 绝缘; 浅灰色	www.wago.com/2002-475
	型号: 2002-475/011-000 交错跨接器; 3插脚; 绝缘; 浅灰色	www.wago.com/2002-475/011-000
	型号: 2002-476 交错跨接器; 6插脚; 绝缘; 浅灰色	www.wago.com/2002-476
	型号: 2002-477 交错跨接器; 7插脚; 绝缘; 浅灰色	www.wago.com/2002-477
	型号: 2002-477/011-000 交错跨接器; 绝缘; 浅灰色	www.wago.com/2002-477/011-000
	型号: 2002-478 交错跨接器; 8插脚; 绝缘; 浅灰色	www.wago.com/2002-478
	型号: 2002-479 交错跨接器; 9插脚; 绝缘; 浅灰色	www.wago.com/2002-479
	型号: 2002-479/011-000 交错跨接器; 绝缘; 浅灰色	www.wago.com/2002-479/011-000
	型号: 2002-480 交错跨接器; 10插脚; 绝缘; 浅灰色	www.wago.com/2002-480
	型号: 2002-481 交错跨接器; 11插脚; 绝缘; 浅灰色	www.wago.com/2002-481
	型号: 2002-481/011-000 交错跨接器; 绝缘; 浅灰色	www.wago.com/2002-481/011-000
	型号: 2002-482 交错跨接器; 12插脚; 绝缘; 浅灰色	www.wago.com/2002-482
	型号: 210-103 导线型跨接器; 绝缘; 黑色	www.wago.com/210-103
	型号: 210-123 导线型跨接器; 绝缘; 蓝色	www.wago.com/210-123

Push-In type wire jumper

变更声明。敬请关注进一步的产品说明文件！

WAGO Electronic (Tianjin) Co., Ltd.
No.5, Quan Hui Road
Wuqing Development Area | Tianjin 301700
Tel.: +86 22 59677688 | Fax: +86 22 59617668
Email: info-cn@wago.com















您有关于我们产品的任何问题吗？
我们非常乐意接听您的来电，+86 (022) 59677688。

	型号: 2009-412 推入式跨接器; 绝缘; 长度60 mm; 黑色	www.wago.com/2009-412
	型号: 2009-414 推入式跨接器; 1.5 mm ² ; 绝缘; 长度110 mm; 黑色	www.wago.com/2009-414
	型号: 2009-414/000-005 推入式跨接器; 1.5 mm ² ; 绝缘; 长度110 mm; 黑色	www.wago.com/2009-414/000-005
	型号: 2009-414/000-006 推入式跨接器; 绝缘; 长度110 mm; 黑色	www.wago.com/2009-414/000-006
	型号: 2009-416 推入式跨接器; 1.5 mm ² ; 绝缘; 长度250 mm; 黑色	www.wago.com/2009-416
Insulation stop		
	型号: 2002-171 绝缘挡块; 0.25 - 0.5 mm ² ; 5件/条; 浅灰色	www.wago.com/2002-171
	型号: 2002-172 绝缘挡块; 0.75 - 1 mm ² ; 5件/条; 深灰色	www.wago.com/2002-172
plug		
	型号: 2002-880 空插头; 宽度10.4 mm; 2极; 4类; 灰色	www.wago.com/2002-880
	型号: 2002-880/1000-411 元件插头; 2极; 带有1个二极管 1N4007; 宽度10.4 mm; 工作温度最高 85°C; 灰色	www.wago.com/2002-880/1000-411
	型号: 2002-880/1000-541 元件插头; 2极; 红色LED; 宽度10.4 mm; 工作温度最高 85°C; 灰色	www.wago.com/2002-880/1000-541
	型号: 2002-880/1000-542 元件插头; 2极; 红色LED; 宽度10.4 mm; 工作温度最高 85°C; 多种颜色	www.wago.com/2002-880/1000-542
	型号: 2002-880/1000-836 元件插头; 2极; 红色LED; 宽度10.4 mm; 工作温度最高 85°C; 灰色	www.wago.com/2002-880/1000-836
Carrier rail		
	型号: 210-112 钢质导轨; 35 x 7.5 mm; 厚度 1 mm; 长度 2 m; 带孔; 符合 EN 60715标准; "孔宽25 mm; 银色	www.wago.com/210-112
	型号: 210-113 钢质导轨; 35 x 7.5 mm; 厚度 1 mm; 长度 2 m; 不带孔; 符合 EN 60715标准; 银色	www.wago.com/210-113
	型号: 210-114 钢质导轨; 35 x 15 mm; 厚度 1.5 mm; 长度 2 m; 不带孔; 类似于EN 60715; 银色	www.wago.com/210-114

变更声明。敬请关注进一步的产品说明文件！

WAGO Electronic (Tianjin) Co., Ltd.
No.5, Quan Hui Road
Wuqing Development Area | Tianjin 301700
Tel.: +86 22 59677688 | Fax: +86 22 59617668
Email: info-cn@wago.com

您有关于我们产品的任何问题吗？
我们非常乐意接听您的来电，+86 (022) 59677688。

	型号: 210-115 钢质导轨; 35 x 7.5 mm; 厚度 1 mm; 长度 2 m; 带孔; 符合 EN 60715标准; "孔宽18 mm; 银色	www.wago.com/210-115
	型号: 210-118 钢质导轨; 35 x 15 mm; 厚度 2.3 mm; 长度 2 m; 不带孔; 符合 EN 60715标准; 银色	www.wago.com/210-118
	型号: 210-196 铝质导轨; 35 x 8.2 mm; 厚度 1.6 mm; 长度 2 m; 不带孔; 类似于EN 60715; 银色	www.wago.com/210-196
	型号: 210-197 钢质导轨; 35 x 15 mm; 厚度 1.5 mm; 长度 2 m; 带孔; 类似于EN 60715; 银色	www.wago.com/210-197
	型号: 210-198 铜质导轨; 35 x 15 mm; 厚度 2.3 mm; 长度 2 m; 不带孔; 符合 EN 60715标准; 铜色	www.wago.com/210-198
tools		
	型号: 210-658 操作工具; 刀口尺寸 : 3.5 x 0.5 mm; 带有绝缘手柄; 弯角; 短; 多种颜色	www.wago.com/210-658
	型号: 210-720 操作工具; 刀口尺寸 : 3.5 x 0.5 mm; 带有绝缘手柄; 多种颜色	www.wago.com/210-720
check		
	型号: 2002-511 模块化TOPJOB@S连接器; 模块化; 适用于跨接器接点槽; 1极; 2,50 mm ² ; 灰色	www.wago.com/2002-511
	型号: 2002-549 间隔模块; 模块化; 例如 , 用于间隔已跨接的接线端子; 灰色	www.wago.com/2002-549
	型号: 2002-552 模块化TOPJOB@S连接器; 模块化; 适用于跨接器接点槽; 2极; 2,50 mm ² ; 灰色	www.wago.com/2002-552
	型号: 2002-553 模块化TOPJOB@S连接器; 模块化; 适用于跨接器接点槽; 3极; 2,50 mm ² ; 灰色	www.wago.com/2002-553
	型号: 2002-554 模块化TOPJOB@S连接器; 模块化; 适用于跨接器接点槽; 4极; 2,50 mm ² ; 灰色	www.wago.com/2002-554
	型号: 2002-555 模块化TOPJOB@S连接器; 模块化; 适用于跨接器接点槽; 5极; 2,50 mm ² ; 灰色	www.wago.com/2002-555
	型号: 2002-556 模块化TOPJOB@S连接器; 模块化; 适用于跨接器接点槽; 6极; 2,50 mm ² ; 灰色	www.wago.com/2002-556
	型号: 2002-557 模块化TOPJOB@S连接器; 模块化; 适用于跨接器接点槽; 7极; 2,50 mm ² ; 灰色	www.wago.com/2002-557
	型号: 2002-558 模块化TOPJOB@S连接器; 模块化; 适用于跨接器接点槽; 8极; 2,50 mm ² ; 灰色	www.wago.com/2002-558
	型号: 2002-559 模块化TOPJOB@S连接器; 模块化; 适用于跨接器接点槽; 9极; 2,50 mm ² ; 灰色	www.wago.com/2002-559
	型号: 2002-560	

变更声明。 敬请关注进一步的产品说明文件！

WAGO Electronic (Tianjin) Co., Ltd.
No.5, Quan Hui Road
Wuqing Development Area | Tianjin 301700
Tel.: +86 22 59677688 | Fax: +86 22 59617668
Email: info-cn@wago.com

您有关于我们产品的任何问题吗？
我们非常乐意接听您的来电， +86 (022) 59677688。

	模块化TOPJOB@S连接器; 模块化; 适用于跨接器接点槽; 10极; 2,50 mm ² ; 灰色	www.wago.com/2002-560
	型号: 2002-611 TOPJOB@S L型测试插头模块; 模块化; 1极; 2,50 mm ² ; 灰色	www.wago.com/2002-611
	型号: 2002-649 TOPJOB@S L型间隔模块; 模块化; 例如, 用于间隔已跨接的接线端子; 灰色	www.wago.com/2002-649
	型号: 2009-174 测试插头适配器; 适于测试插头4 mm Ø; 用于测试 TOPJOB@S 轨道式端子板; 灰色	www.wago.com/2009-174
	型号: 2009-182 测试插头; 适用最大 2.5 mm ² ; 可不使用任何工具与单根测试导线 (0.08 - 2.5 mm ²) 连接; 灰色	www.wago.com/2009-182
	型号: 210-136 测试插头; 2 mm Ø; 带500 mm长电缆; 红色	www.wago.com/210-136

ferrule

	型号: 216-241 冷压接头; 标识套管, 适用截面积 0.5 mm ² / AWG 20; 绝缘; 电镀锡; 电解铜; 气密压接; 符合DIN 46288-4 /09.09标准; 白色	www.wago.com/216-241
	型号: 216-242 冷压接头; 标识套管, 适用截面积 0.75 mm ² / AWG 18; 绝缘; 电镀锡; 电解铜; 气密压接; 符合DIN 46288-4 /09.09标准; 灰色	www.wago.com/216-242
	型号: 216-243 冷压接头; 套管, 适于1 mm ² / AWG 18; 绝缘; 电镀锡; 电解铜; 气密压接; 符合DIN 46288-4/09.09标准; 红色	www.wago.com/216-243
	型号: 216-244 冷压接头; 套管, 适于1.5 mm ² / AWG 16; 绝缘; 电镀锡; 电解铜; 气密压接; 符合DIN 46288-4/09.09标准; 黑色	www.wago.com/216-244
	型号: 216-246 冷压接头; 套管, 适于2.5 mm ² / AWG 14; 绝缘; 电镀锡; 电解铜; 气密压接; 符合DIN 46288-4/09.09标准; 蓝色	www.wago.com/216-246
	型号: 216-262 冷压接头; 标识套管, 适用截面积 0.75 mm ² / AWG 18; 绝缘; 电镀锡; 电解铜; 气密压接; 符合DIN 46288-4 /09.09标准; 灰色	www.wago.com/216-262
	型号: 216-263 冷压接头; 套管, 适于1 mm ² / AWG 18; 绝缘; 电镀锡; 电解铜; 气密压接; 符合DIN 46288-4/09.09标准; 红色	www.wago.com/216-263
	型号: 216-264 冷压接头; 套管, 适于1.5 mm ² / AWG 16; 绝缘; 电镀锡; 电解铜; 气密压接; 符合DIN 46288-4/09.09标准; 黑色	www.wago.com/216-264
	型号: 216-266 冷压接头; 套管, 适于2.5 mm ² / AWG 14; 绝缘; 电镀锡; 电解铜; 气密压接; 符合DIN 46288-4/09.09标准; 蓝色	www.wago.com/216-266

变更声明。敬请关注进一步的产品说明文件！

WAGO Electronic (Tianjin) Co., Ltd.
No.5, Quan Hui Road
Wuqing Development Area | Tianjin 301700
Tel.: +86 22 59677688 | Fax: +86 22 59617668
Email: info-cn@wago.com

您有关于我们产品的任何问题吗？
我们非常乐意接听您的来电，+86 (022) 59677688。



**下载
文档**

Bid Text

2102-5301 docx - Datei	2019年5月14日	docx 15.2 kB	下载
---------------------------	------------	-----------------	----

2102-5301 X81 - Datei	2019年5月15日	xml 4.1 kB	下载
--------------------------	------------	---------------	----

Additional Information

Technical explanations	2019年4月3日	pdf 2.2 MB	下载
------------------------	-----------	---------------	----

CAD/CAE-Data

CAD data

2D/3D Models 2102-5301		URL	下载
------------------------	--	-----	----

CAE data

ZUKEN Portal 2102-5301		URL	下载
------------------------	--	-----	----

EPLAN Data Portal 2102-5301		URL	下载
-----------------------------	--	-----	----

Environmental Product Compliance

Compliance Search

Environmental Product Compliance 2102-5301		URL	下载
--	--	-----	----

3线普通接线端子; 具有操作手柄及推压键; 2.5 mm²; 有测试插孔; 侧面/中心标记; 适于35 x 15 和 35 x 7.5导轨; Push-in CAGE CLAMP®; 2,50 mm²; 灰色

Installation Notes

连接导线

变更声明。 敬请关注进一步的产品说明文件！

WAGO Electronic (Tianjin) Co., Ltd.
No.5, Quan Hui Road
Wuqing Development Area | Tianjin 301700
Tel.: +86 22 59677688 | Fax: +86 22 59617668
Email: info-cn@wago.com

您有关于我们产品的任何问题吗？
我们非常乐意接听您的来电， +86 (022) 59677688。

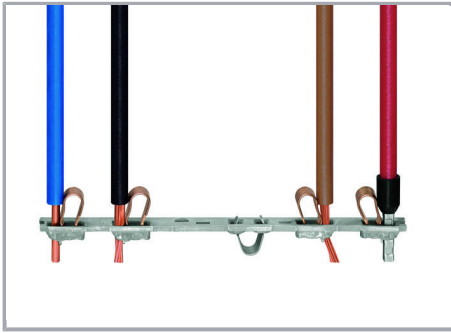

All conductor types at a glance

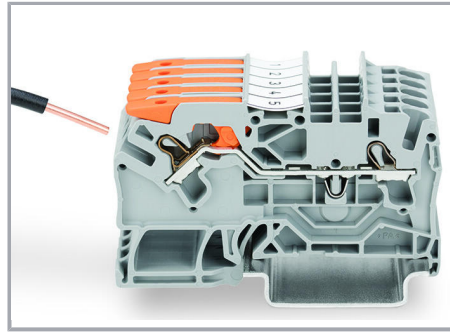

Push-in termination of solid conductors

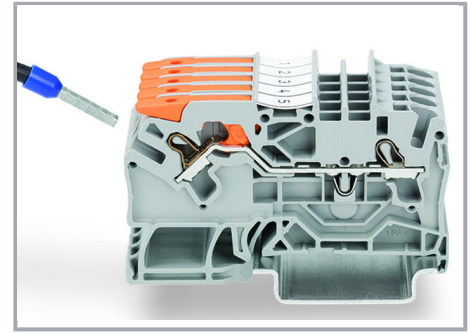

Push-in termination of fine-stranded conductors with ferrules

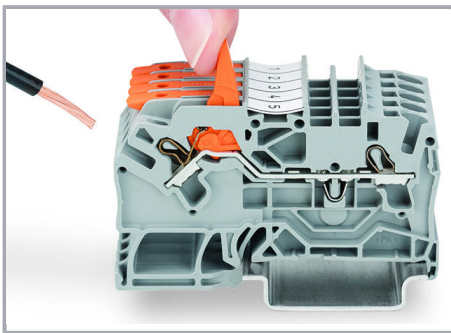

Pull the lever up until it stops, then connect the fine-stranded conductor.

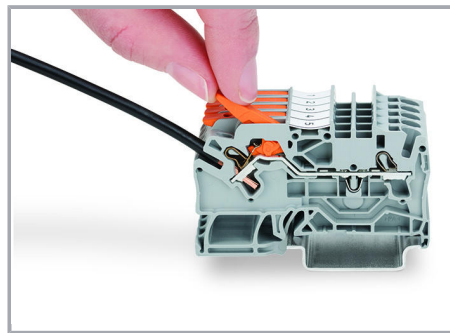

Push the lever back down – done!

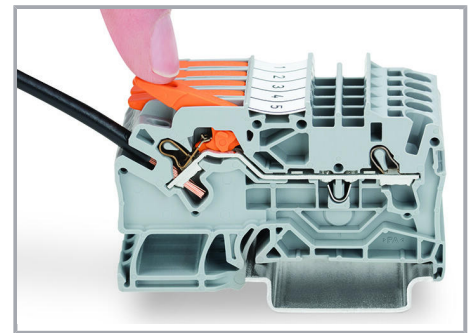

Push the lever back down – done!

跨接

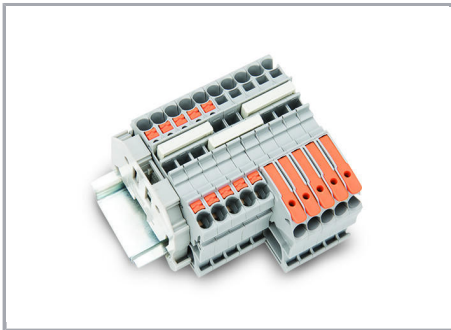

Insert a push-in type jumper bar and push down until it hits the backstop.

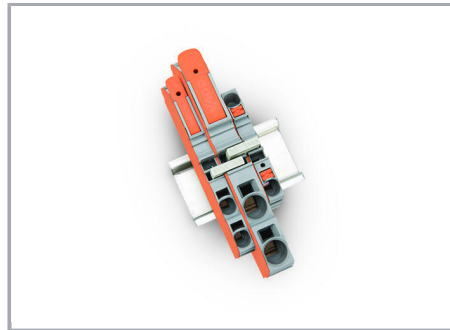

Commoning with step-down jumpers.

测试

变更声明。 敬请关注进一步的产品说明文件！

WAGO Electronic (Tianjin) Co., Ltd.
No.5, Quan Hui Road
Wuqing Development Area | Tianjin 301700
Tel.: +86 22 59677688 | Fax: +86 22 59617668
Email: info-cn@wago.com

您有关于我们产品的任何问题吗？
我们非常乐意接听您的来电， +86 (022) 59677688。

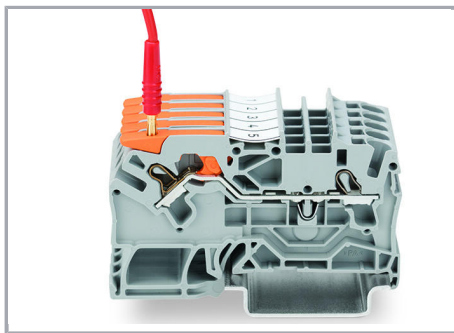

Testing with a 2 mm Ø test plug (max. 42 V).

标记

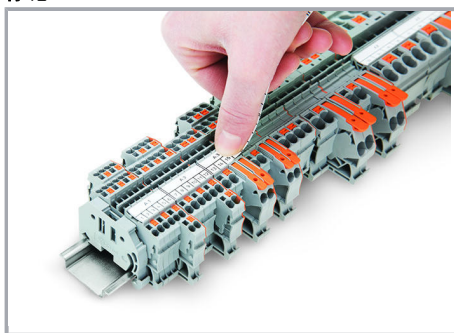

Snapping a marking strip into a marker slot.



Snapping a marking strip into the marker slot.

产品系列

TOPJOB® S

TOPJOB® S: In various industrial applications and modern building installations, WAGO's wide and versatile range of rail-mount terminal blocks provides more than just reliable electrical connections.

[显示该系列的所有产品。](#)

变更声明。 敬请关注进一步的产品说明文件！

WAGO Electronic (Tianjin) Co., Ltd.
No.5, Quan Hui Road
Wuqing Development Area | Tianjin 301700
Tel.: +86 22 59677688 | Fax: +86 22 59617668
Email: info-cn@wago.com

您有关于我们产品的任何问题吗？
我们非常乐意接听您的来电， +86 (022) 59677688。